

# BiPAP<sup>®</sup> S/T

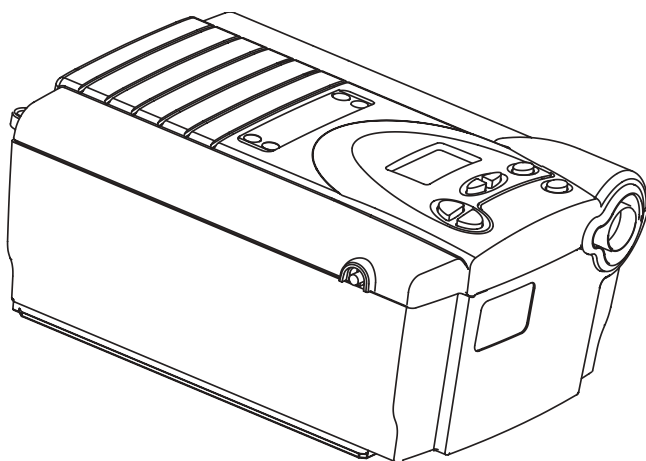

## User Manual



This BiPAP system is covered by one or more of the following patents:  
US Patent Nos. 5,148,802; 5,313,937; 5,433,193; 5,632,269; 5,803,065;  
6,029,664; 6,305,374 and 6,539,940; Australian Patent Nos. 638054, 661575,  
698519, 723681, 734319, and 733655; Canadian Patent Nos. 2,162,981 and  
2,259,795; European Patent Pub. No. 0425092B1; and Japanese Patent  
Nos. 2832812, 2137336, and 2926392. Other U.S. and Foreign Patents  
Pending.

---

# TABLE OF CONTENTS

CHAPTER 1: PACKAGE CONTENTS .....	4
CHAPTER 2: WARNINGS AND CAUTIONS .....	5
2.1 WARNINGS .....	5
2.2 CAUTIONS .....	7
2.3 INTENDED USE .....	7
2.4 CONTRAINDICATIONS .....	8
2.5 PRECAUTIONS .....	8
CHAPTER 3: INTRODUCTION .....	9
3.1 DEFINITIONS .....	9
3.2 WHAT IS THE BiPAP S/T? .....	11
3.3 SYMBOLS .....	12
3.4 HOW TO CONTACT RESPIRONICS .....	12
CHAPTER 4: CONTROLS AND	
DISPLAY FEATURES .....	13
4.1 PRESSURE ON/OFF BUTTON .....	13
4.2 CONTROL PANEL .....	14
4.2.1 CONTROL BUTTONS .....	14
4.2.2 ALARM AND POWER INDICATORS .....	15
4.2.3 DISPLAY SCREEN .....	16
4.2.4 BREATHING CIRCUIT CONNECTION .....	17
4.2.5 REAR PANEL .....	18
CHAPTER 5: SETTING UP THE DEVICE .....	19
5.1 INSTALLING THE AIR FILTERS .....	19
5.2 WHERE TO PLACE THE BiPAP S/T .....	20
5.3 CONNECTING THE BREATHING CIRCUIT .....	21
5.4 COMPLETE THE SETUP .....	23
5.5 PLUGGING IT IN .....	23
5.5.1 USING AC POWER .....	24
5.5.2 USING DC POWER .....	25
CHAPTER 6: OPERATING THE BiPAP S/T .....	26
6.1 STARTING THE DEVICE .....	26
6.2 CHANGING THE DEVICE SETTINGS .....	29
6.2.1 CHANGING THE HUMIDIFIER SETTING .....	30
6.2.2 NAVIGATING THE USER DISPLAY SCREENS .....	30
6.2.2.1 CHANGING THE FLEX SETTING .....	32
6.2.2.2 CHANGING THE RISE TIME SETTING .....	33
6.2.2.3 CHANGING THE RAMP STARTING PRESSURE .....	34
6.2.2.4 CHANGING THE LED BACKLIGHT SETTING .....	35

---

CHAPTER 7: ALARMS .....	36
7.1 INTRODUCTION TO ALARMS .....	36
7.2 WHAT TO DO WHEN AN ALARM OCCURS .....	38
7.3 ALARM TABLES .....	39
7.3.1 HIGH PRIORITY ALARMS .....	39
7.3.2 MEDIUM PRIORITY ALARMS .....	40
7.3.3 LOW PRIORITY ALARMS .....	40
CHAPTER 8: TROUBLESHOOTING .....	41
CHAPTER 9: CLEANING AND MAINTENANCE .....	45
9.1 CLEANING THE DEVICE .....	45
9.2 CLEANING OR REPLACING THE INLET FILTERS .....	45
CHAPTER 10: ACCESSORIES .....	48
10.1 ADDING A HUMIDIFIER .....	48
10.2 ADDING OXYGEN TO THE DEVICE .....	48
CHAPTER 11: SPECIFICATIONS .....	49
ENVIRONMENTAL .....	49
PHYSICAL .....	49
ELECTRICAL .....	49
PRESSURE .....	50
CONTROL ACCURACY .....	50
DISPOSAL .....	50
APPENDIX A: EMC INFORMATION .....	51
GUIDANCE AND MANUFACTURER'S DECLARATION - ELECTROMAGNETIC EMISSIONS .....	51
LIMITED WARRANTY .....	56

# CHAPTER 1: PACKAGE CONTENTS

Your BiPAP S/T should include the following items. If any of these items are missing, contact your home care provider.

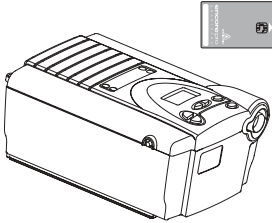

BiPAP S/T with  
Encore<sup>®</sup> Pro SmartCard<sup>™</sup>

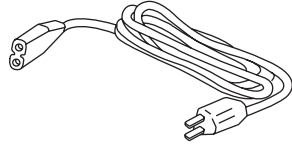

Power Cord

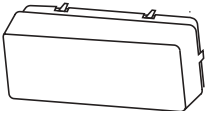

Filter Cap

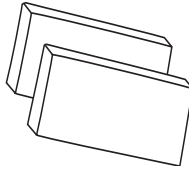

Gray Foam Filters

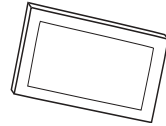

Ultrafine Filter

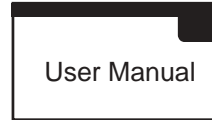

User Manual

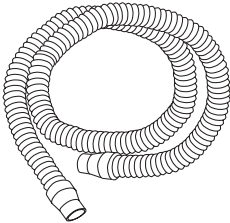

Flexible Tubing  
6 ft. (1.83 m) X 22 mm i.d.

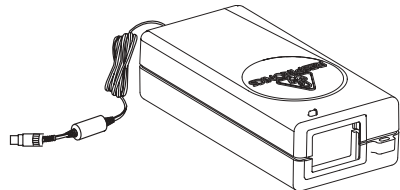

External AC Power Supply

---

## CHAPTER 2: WARNINGS AND CAUTIONS

**WARNING:** Indicates the possibility of injury to the user or operator.

**CAUTION:** Indicates the possibility of damage to the device.

**NOTE:** Places emphasis on an operating characteristic.

### 2.1 WARNINGS

- This manual serves as a reference. The instructions in this manual are not intended to supersede the instructions of your health care professional.
- You should read and understand this entire manual before using the device.
- The device is not intended to provide your total ventilatory requirement.
- The prescription must only be adjusted by a trained home care provider.
- The device should be used only with masks and connectors recommended by Respironics or with those recommended by the health care professional or respiratory therapist. A mask should not be used unless the device is turned on and operating properly. The exhalation port(s) associated with the mask should never be blocked.

**Explanation of the Warning:** The BiPAP S/T is intended to be used with special masks or connectors that have exhalation ports to allow continuous flow of air out of the mask. When the device is turned on and functioning properly, new air from the device flushes the exhaled air out through the mask exhalation port. However, when the device is not operating, enough fresh air will not be provided through the mask, and exhaled air may be rebreathed. Rebreathing of exhaled air for longer than several minutes can in some circumstances lead to suffocation. This warning applies to most models of CPAP machines.

- Use only the breathing circuit provided by your home care provider.
- When using a breathing circuit that contains a mask with an integrated exhalation port or a circuit with a separate exhalation device, do not tape, seal, or otherwise block the vent openings. Doing so could result in suffocation.

- 
- If oxygen is used with the device, the oxygen flow must be turned off when the device is not in use.  
**Explanation of the Warning:** When the device is not in operation and the oxygen flow is left on, oxygen delivered into the ventilator tubing may accumulate within the device's enclosure. Oxygen accumulated in the ventilator enclosure will create a risk of fire.
  - If you are using oxygen, the BiPAP S/T must be equipped with the Respironics Pressure Valve (Part number 302418). Failure to use the Pressure Valve could result in a fire hazard.
  - Oxygen supports combustion. Oxygen should not be used while smoking or in the presence of an open flame.
  - Do not use the device in the presence of a flammable anaesthetic mixture in combination with oxygen or air, or in the presence of nitrous oxide.
  - Do not use the device if the room temperature is above 95° F (35°C). If the device is used at room temperatures above 95° F, the temperature of the airflow may exceed 106° F (41°C), which could cause irritation to your airway.
  - Do not operate the device in direct sunlight or near a heating appliance because these conditions can increase the temperature of the air coming out of the device.
  - When using this product, IEC 60601-1-1 requirements (safety requirements for medical electrical systems) must be met.
  - For proper use, the power supply **must** be placed feet down, in the upright position.
  - When the BiPAP S/T is used with a humidifier, position the humidifier so that the water level in the humidifier is lower than you, and the humidifier is on the same level or lower than the BiPAP S/T.
  - Do not attempt to wear your mask without the device turned on. Doing so could result in CO<sub>2</sub> rebreathing.
  - If you notice any unexplained changes in the performance of the BiPAP S/T, if it is making unusual or harsh sounds, if it and/or the power supply has been dropped or mishandled, if the enclosure is broken, or if water has entered the unit, discontinue use and contact your home care provider.
  - Repairs and adjustments must be performed by Respironics - authorized service personnel only. Unauthorized service could cause injury, invalidate the warranty, or result in costly damage.
  - Periodically inspect electrical cords, cables, and the power supply device for damage or signs of wear.

- 
- To avoid electrical shock, unplug the device before cleaning it.
  - Pins of connectors identified with the ESD warning symbol should not be touched. Connections should not be made to these connectors unless ESD precautionary procedures are used. Precautionary procedures include methods to prevent build-up of electrostatic discharge (e.g., air conditioning, humidification, conductive floor coverings, non-synthetic clothing), discharging one's body to the frame of the equipment or system or to earth or a large metal object, and bonding oneself by means of a wrist strap to the equipment or system or to earth.

## 2.2 CAUTIONS

---

**CAUTION!** US federal law restricts this device to sale by or on the order of a physician.

- 
- The BiPAP S/T may only be operated at temperatures between 41° F (5°C) and 95° F (35°C).
  - A properly installed, undamaged reusable foam inlet filter is required for proper operation.
  - Do not immerse the device or allow any liquid to enter the enclosure or the inlet filter.
  - Condensation may damage the device. Always allow the device to reach room temperature before use.
- 

**NOTE:** Additional warnings, cautions, and notes are located throughout this manual.

---

## 2.3 INTENDED USE

The BiPAP S/T is intended to provide noninvasive ventilation in adult patients (>66 lb.) for the treatment of respiratory insufficiency (a condition in which the patient can continue without ventilation for some period of time, such as overnight) or obstructive sleep apnea. This device may be used in the hospital or home. The device is intended for use with nasal masks and full-face masks as recommended by Respironics.

## 2.4 CONTRAINDICATIONS

The BiPAP S/T should not be used if you have severe respiratory failure without a spontaneous respiratory drive. If any of the following conditions apply to you, consult your physician before using the device:

- Inability to maintain a patent airway or adequately clear secretions
- At risk for aspiration of gastric contents
- Diagnosed with acute sinusitis or otitis media
- Allergy or hypersensitivity to the mask materials where the risk from allergic reaction outweighs the benefit of ventilatory assistance
- Epistaxis, causing pulmonary aspiration of blood
- Hypotension

## 2.5 PRECAUTIONS

- Immediately report any unusual chest discomfort, shortness of breath, or severe headache.
- If skin irritation or breakdown develops from the use of the mask, refer to the mask instructions for appropriate action.
- The following are potential side effects of noninvasive positive pressure therapy:
  - Ear discomfort
  - Conjunctivitis
  - Skin abrasions due to noninvasive interfaces
  - Gastric distention (aerophagia)

---

## CHAPTER 3: INTRODUCTION

This chapter contains the following information:

- Definitions for common terms used throughout this manual
- An overview of the device
- An explanation of the symbols used on the device and throughout this manual
- Contact information

### 3.1 DEFINITIONS

The following terms appear throughout this manual:

Apnea	A condition marked by the cessation of spontaneous breathing.
CPAP	Continuous Positive Airway Pressure
EPAP	Expiratory Positive Airway Pressure
High Priority Alarm	Alarm signal indicating a condition that requires immediate attention
IPAP	Inspiratory Positive Airway Pressure
Low Priority Alarm	Alarm signal indicating an informational message.
Medium Priority Alarm	Alarm signal indicating a condition that requires operator awareness.
Operate State	The state of the device when the unit and the airflow are both on.
Standby State	The state of the device when the unit is on, but the airflow is off.
OSA	Obstructive Sleep Apnea
Ramp	A feature that may increase patient comfort when therapy is started. The ramp feature reduces the pressure and then gradually increases (ramps) the pressure to the prescription setting, so you can fall asleep more comfortably.
Rise Time	The time it takes for the device to change from EPAP to IPAP. You can adjust this time for your comfort.

---

RR	Respiratory Rate
Spontaneous (S)	A bi-level mode which responds to both your inhalation and exhalation by increasing pressure when you start to inhale and decreasing pressure when you start to exhale. There is no automatic delivery of a breath if you do not inhale.
Spontaneous/Timed (S/T)	A bi-level mode which responds to both your inhalation and exhalation by increasing pressure when you start to inhale and decreasing pressure when you start to exhale. If you do not start inhaling within a set time, the device automatically starts inhalation. When the device starts inhalation, it controls the time of inhalation and automatically decreases the pressure for exhalation within a set time.

### 3.2 WHAT IS THE BiPAP S/T?

The BiPAP S/T, shown in Figure 3–1, supplies air pressure through a breathing circuit.

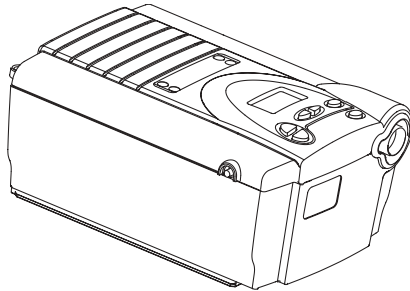
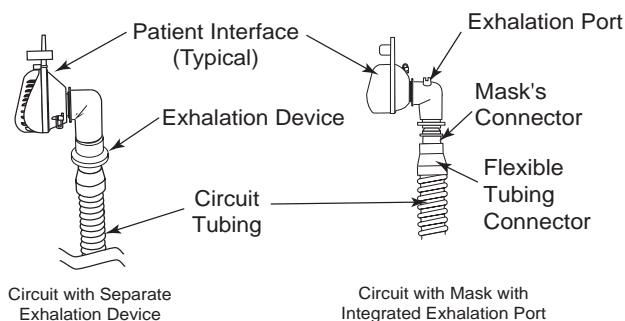

Figure 3–1 The BiPAP S/T Unit

The circuit, shown in Figure 3–2, consists of:

- Circuit tubing to deliver air from the device to your interface (e.g., mask)
- A mask or other patient interface device to deliver the prescribed pressure to your nose or nose and mouth, depending on which interface has been prescribed for you
- An exhalation device to vent exhaled air from the circuit



**Figure 3–2 Typical Breathing Circuits**

---

**NOTE:** The exhalation port may be part of the mask or may be part of a separate exhalation device, but is required to minimize the potential for CO<sub>2</sub> rebreathing.

---

The system senses your breathing effort and changes pressure levels when you inhale and exhale depending on the mode of operation.

---

**WARNING:** The device can operate on AC or DC power. The DC power option is not intended as a battery backup.











---

**CAUTION:** When DC power is obtained from a vehicle battery, the device should not be used while the vehicle's engine is running.

---

### 3.3 SYMBOLS

The symbols shown below are used on the device and throughout this manual.

Symbol	Meaning
	Attention, consult accompanying documents
	DC Power
	Pressure On/Off
	Type BF Applied Part
	Class II (Double Insulated)
	European CE Declaration of Conformity
	Notified Body Approval for Standards Compliance
	Canadian/US Certification
	Electrostatic Discharge
IPX1	Drip Proof Equipment
	UL Recognized for Canada and the United States
	TUV Safety Standard Compliance
	No User Serviceable Parts

### 3.4 HOW TO CONTACT RESPIRONICS

To have your unit serviced, contact your home care provider. If you need to contact Respironics directly, call 1-800-345-6443 or use the following address:



---

## CHAPTER 4: CONTROLS AND DISPLAY FEATURES

Figure 4–1 shows the location of the device’s alarm power indicators, control panel, **Pressure On/Off** button, and breathing circuit connection.

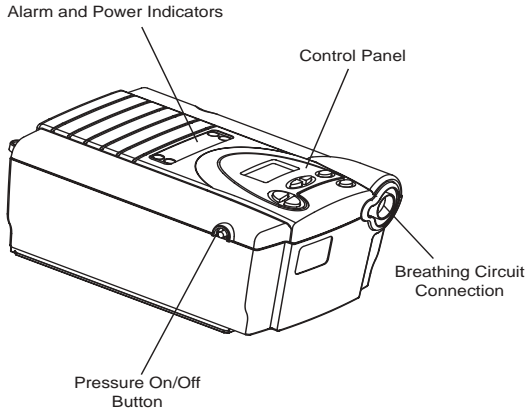

**Figure 4–1 Front and Top**

### 4.1 PRESSURE ON/OFF BUTTON

The **Pressure On/Off** button, located on the side of the unit, starts and stops the unit’s airflow. Press the button in to turn the airflow on. This puts the device in the **Operate** state. Depress the button to turn the airflow off and put the device in the **Standby** state.

When the device is in Standby, any ramp in progress is terminated, the alarms are reset (except for the System Errors alarm), and the humidifier is turned off.

The **Pressure On/Off** button is independent of the display screen.

## 4.2 CONTROL PANEL

The control panel contains the following control buttons and indicators.

### 4.2.1 CONTROL BUTTONS

The control buttons on the control panel are shown in Figure 4–2.

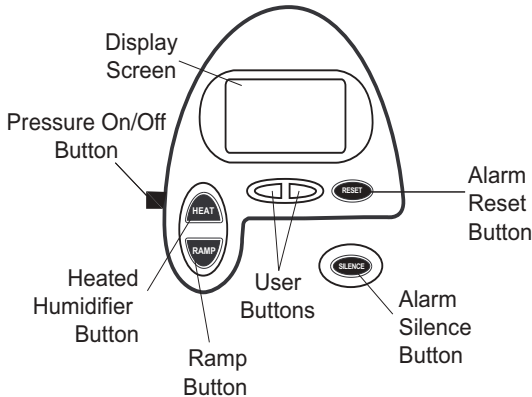
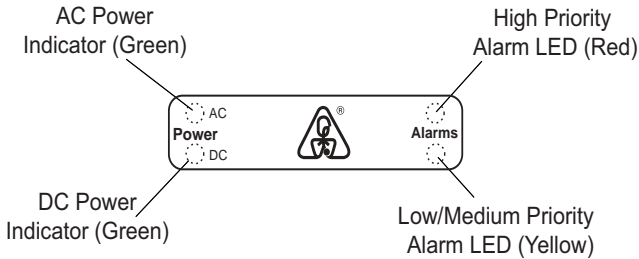

**Figure 4–2 Control Panel**

- HEAT** When the optional REMstar heated humidifier is prescribed, this button controls the humidifier’s heater plate setting. Follow the instructions provided with the humidifier. You can also use this button to adjust the settings shown in the user menu screens.
- RAMP** When the airflow is turned on and the ramp function is enabled, this button lowers the airflow pressure, allowing you to fall asleep more easily. You can also use this button to adjust the settings shown in the user menu screens.
- USER** The left and right user buttons allow you to navigate the display screens.
- SILENCE** This button silences the audible portion of an alarm for one minute. You can also use this button to exit the user menu screens.
- RESET** This button allows you to clear an alarm and reset the device for alarm detection.

## 4.2.2 ALARM AND POWER INDICATORS

Figure 4–3 shows the device’s alarm and power indicators.



**Figure 4–3 Alarm and Power Indicators**

<b>AC Power Indicator</b>	This green LED lights up when the device is connected to AC Power.
<b>DC Power Indicator</b>	This green LED lights up when the device is connected to DC power.
<b>Red Alarm Indicator</b>	The red LED lights up when a high priority alarm occurs.
<b>Yellow Alarm Indicator</b>	This yellow LED lights up when a medium or low priority alarm occurs.

---

**NOTE:** All LED indicators temporarily turn on when the unit is first plugged in.

---

### 4.2.3 DISPLAY SCREEN

The display shows you the measured pressure and displays alarm messages. A backlight activates when any of the keys are pressed and remains on until there are no keystrokes for one minute.

Figure 4–4 shows the display screen.

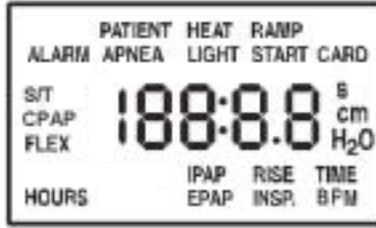

Figure 4–4 Display Screen

The information shown on the display screen is defined as follows:

<b>ALARM</b>	Indicates that the device requires user attention as indicated on the screen.
<b>APNEA</b>	Indicates that an apnea alarm has occurred.
<b>BPM</b>	Indicates that a breath rate setting is being displayed. <b>BPM</b> flashes on the screen when the device is providing timed backup breaths in S/T mode.
<b>CARD</b>	Indicates that a SmartCard is inserted and detected.
<b>CPAP</b>	Indicates that the device is in the Continuous Positive Airway Pressure (CPAP) mode.
<b>cm H<sub>2</sub>O</b>	Indicates that the alphanumeric digits are displaying a pressure value.
<b>EPAP</b>	Indicates that an EPAP pressure setting is being displayed.
<b>FLEX</b>	Indicates that a Bi-Flex comfort setting is being displayed.
<b>HEAT</b>	Indicates that the humidifier is turned on and/or its setting is displayed.

<b>HOURS</b>	Indicates that the Therapy Hour Meter is being displayed.
<b>INSP. TIME</b>	Indicates that the inspiratory time setting is being displayed.
<b>IPAP</b>	Indicates that an IPAP pressure setting is being displayed.
<b>LIGHT</b>	Indicates that the keypad LED backlight setting is being displayed or is active.
<b>PATIENT</b>	Indicates that a Patient Disconnect alarm is active.
<b>RAMP</b>	Indicates that the Ramp function is in progress.
<b>RAMP START</b>	Indicates that the Ramp Starting Pressure is being displayed.
<b>RISE TIME</b>	Indicates that a rise time setting is being displayed.
<b>S</b>	The "s" on the right side of the display, above "cm H <sub>2</sub> O", indicates that the alphanumeric digits are displaying a time value, in seconds.
<b>S or S/T</b>	Indicates that the device is in the Spontaneous mode if only the S appears, or the Spontaneous/Timed mode if the S/T appears.

#### 4.2.4 BREATHING CIRCUIT CONNECTION

Figure 4–5 shows where the circuit tubing connects to the device.

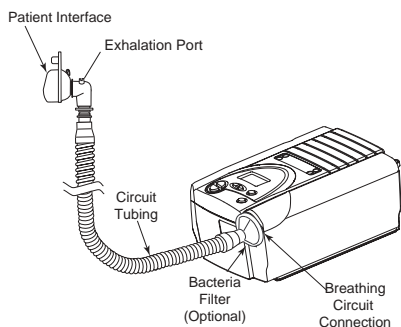
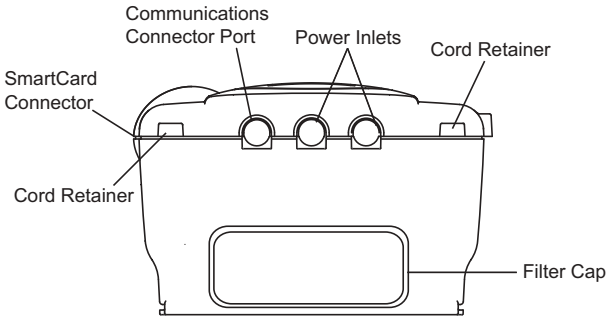

Figure 4–5 Typical Breathing Circuit Connection

## 4.2.5 REAR PANEL

Figure 4–6 shows the rear panel.



**Figure 4–6 Rear Panel**

**NOTE:** The SmartCard Connector is located on the side of the device.

**WARNING:** In order to ensure proper protection against electric shock, only communications accessories with an IEC 60601-1 approved power supply may be connected through the SleepLink interface. All IEC 950 devices must only be connected to the 7-pin connector with the Respironics Isolation cable (Part Number 1012865).

The rear panel contains the following:

<b>Communications Connector</b>	This connector accepts the Respironics Communications cable for computer and external communications, or a remote alarm, when available. (Use only with an IEC 60950 approved computer.)
<b>Power Inlets</b>	There are two power inlets on the rear panel, one for connecting the external AC power supply and another for connecting the external DC power adapter.
<b>Filter Cap</b>	The filter cap can be removed to inspect the inlet air filters.
<b>Cord Retainers</b>	Two cord retainers are located on the rear panel to provide strain relief for the power cord.

---

## CHAPTER 5: SETTING UP THE DEVICE

This chapter provides instructions on how to:

- Install the air filters
- Position the unit
- Connect the breathing circuit
- Plug the device in using AC or DC power

### 5.1 INSTALLING THE AIR FILTERS

---

**CAUTION:** A properly installed, undamaged foam filter is required for proper operation.

---

The BiPAP S/T uses a gray foam filter that is washable and reusable, and an optional white, ultra-fine filter that is disposable. One filter of each kind is supplied with the unit.

If your home care provider did not install the inlet air filters, you must install at least the gray foam filter before using the device.

1. Place the gray foam filter on top of the ultra-fine filter (if using the ultra-fine filter).
2. Slide the filters into the air inlet at the rear of the device, and push them down into the recess as shown in Figure 5-1.

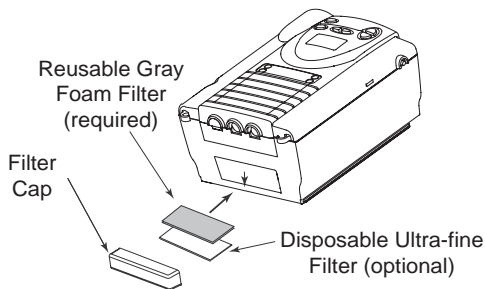

**Figure 5–1** Installing the Filters

3. Attach the filter cap as shown in Figure 5–2. Position the cap so that the small opening on the cap is facing down. Insert the caps bottom tabs into the openings below the filter area. Snap the cap into place.

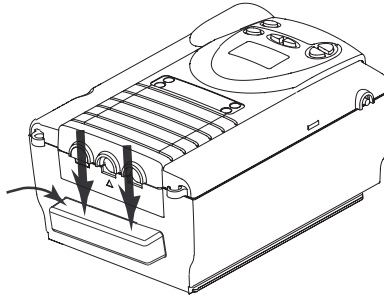

**Figure 5–2 Attaching the Filter Cap**

---

**NOTE:** The filter cap should be installed with the air inlet opening at the bottom.

---

See Chapter 9 to clean or replace the filters.

## 5.2 WHERE TO PLACE THE BiPAP S/T

Place the device on its base somewhere within easy reach of where you will use it. Make sure that the air inlet on the rear of the unit is not blocked. Place the unit on a hard, flat surface. If you block the air flow around the unit, the device may not work properly.

---

**WARNING:** Position the humidifier so the water level is lower than you, and the humidifier is on the same level or lower than the device. See the humidifier instructions for complete setup information.

---

### 5.3 CONNECTING THE BREATHING CIRCUIT

To connect your breathing circuit to the device, complete the following steps:

1. Connect one end of the circuit tubing to the outlet of the bacteria filter (if using one) and connect the inlet of the bacteria filter to the large connector on the device as shown in Figure 5–3.

If you are not using a bacteria filter, connect the end of the circuit tubing directly to the outlet connector on the device.

---

**NOTE:** Follow the recommendations of your home care provider for using the optional bacteria filter.

---

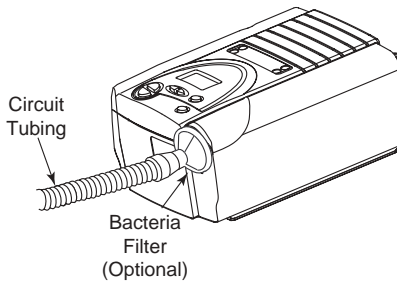

**Figure 5–3 Connecting the Tubing to the Outlet**

2. Connect the tubing to the mask:
  - A. If you are using a mask with a built-in exhalation port, connect the mask's connector to the circuit tubing, as shown in Figure 5–4.

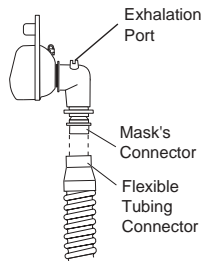

**Figure 5–4 Connecting a Mask with a Built-In Exhalation Port**

- 
- B. If you are using a mask with a separate exhalation device, connect the open end of the circuit tubing to the exhalation device as shown in Figure 5–5. Position the exhalation device so that the vented air is blowing away from your face.

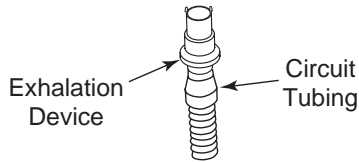

**Figure 5–5 Connecting an Exhalation Device**

Connect the mask's connector to the exhalation device, as shown in Figure 5–6. See the mask instructions for complete setup information.

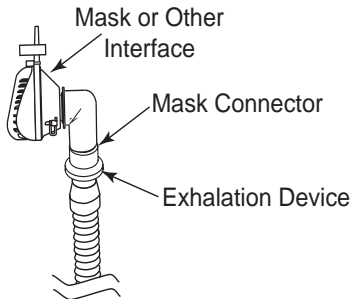

**Figure 5–6 Connecting the Mask**

---

**WARNING:** The exhalation device is designed to exhaust CO<sub>2</sub> from the patient circuit. Do not block or seal the ports on the exhalation device.

---

3. Attach the headgear to the mask. See the instructions that came with your headgear.

---

## 5.4 COMPLETE THE SETUP

Figure 5–7 shows the completed breathing circuit setup.

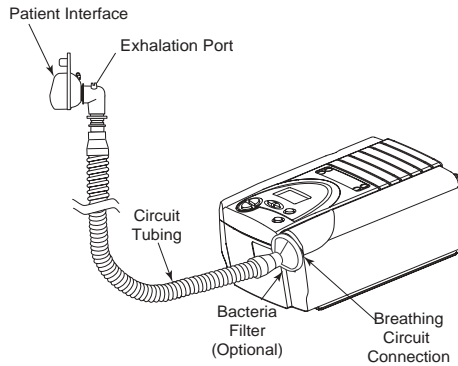

**Figure 5–7 Complete Breathing Circuit**

## 5.5 PLUGGING IT IN

You can use AC or DC power to operate the device.

---

**WARNING:** The DC power option is not intended as a battery backup when using AC power.

---

---

**WARNING:** For proper use, the power supply **must** be placed feet down, in the upright position, as shown in Figure 5–7.

---

---

### 5.5.1 USING AC POWER

Complete the following steps to operate the device using AC power:

1. Plug the pronged end of the AC power supply's cord into an electrical outlet.
2. The external AC power supply features a cord retainer to provide strain relief for the AC power cord. Wrap the cord around the AC power supply's cord retainer, using the wire tie supplied with your power supply.

---

**WARNING:** Never plug the AC power supply into an outlet that is controlled by a wall switch.

---

---

**WARNING:** Route the wires to avoid tripping.

---

3. Leaving a small amount of slack in the cord, connect the cord on the other side of the power supply to one of the power inlets on the device, as shown in Figure 5–8. The power cord has a locking connector. To properly plug the cord in:
  - a. Pull the locking mechanism back.
  - b. Push the connector into place.
  - c. Release the lock.

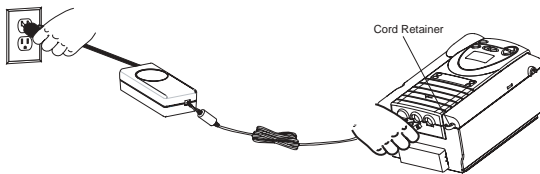

**Figure 5–8 Plugging in the AC Power Supply**

---

**NOTE:** You can plug the cord into either of the power inlets on the back of the device.

---

4. Wrap the cord around the device's power cord retainer, which provides strain relief for the power cord.
5. Ensure that all connections are secure.

---

**NOTE:** If you need to disconnect the power cord from the device, slide the locking connector back and then remove the power cord.

---

### 5.5.2 USING DC POWER

You can operate the device on DC power by using the Respironics DC power adapter accessory (when available). See the DC power adapter instructions for more information.

---

**CAUTION:** Only use the Respironics DC power adapter available from your home care provider. Use of any other system may cause damage to the device or the vehicle.

---

**CAUTION:** When DC power is obtained from a vehicle battery, the device should not be used while the vehicle's engine is running. Damage to the device or the vehicle may occur.

---

## CHAPTER 6: OPERATING THE DEVICE

This chapter explains how to start the device and change the settings.

### 6.1 STARTING THE BiPAP S/T

1. Plug in the device to an AC or DC power source to power up the unit. A confirmation alarm sounds, and the control pad buttons light up.

**NOTE:** If the alarm does not sound or the buttons do not light up, the device requires servicing. Contact your home care provider.

Several screens appear initially during this step:

- a. The first screen that appears is the Self Test screen, shown in Figure 6–1. This is the internal test performed by the device.



Figure 6–1 Self Test Screen

- b. The next screen displays the software version, as shown in Figure 6–2:

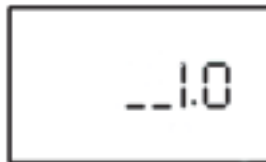

Figure 6–2 Software Version Screen

---

**NOTE:** Version 1.0 shown in Figure 6–2 is an example. Your device may have a higher software version installed.

---

- c. The third screen to appear is the Blower Hours screen, which displays the blower hours time meter:

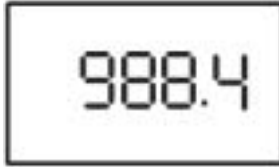

**Figure 6–3 Blower Hours Screen**

---

**NOTE:** With the exception of the **Pressure On/Off** button, the control pad is inactive during these first three screens. Each of these screens appears for approximately 1-3 seconds.

---

- d. The next screen that appears is the Standby screen, shown in Figure 6–4. This indicates that the device is in the Standby state.

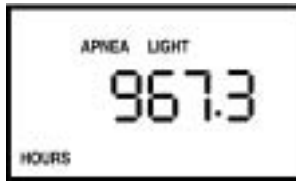

**Figure 6–4 Standby Screen**

2. Press the **Pressure On/Off** button to put the unit into the Operate state. The Monitoring screen, shown in Figure 6–5, appears.

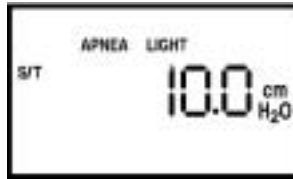

**Figure 6–5 Monitoring Screen**

Both the Monitoring and the Standby screens display the Patient Disconnect, Apnea, and LED backlight icons if these features are enabled. Additionally, the SmartCard icon displays if a SmartCard is inserted.

The Monitoring screen also displays the actual measured pressure and the Flex icon if Flex is enabled.

3. Put on your mask assembly when the air starts to flow.
4. Make sure that no air is leaking from your mask into your eyes. If it is, adjust the mask and headgear until the air leak stops. See the instructions that came with your mask for more information.

---

**NOTE:** A small amount of mask leak is normal and acceptable. Correct large mask leaks or eye irritation from an air leak as soon as possible.

---

5. If you are using the device while sleeping, try placing the tubing from the device over your headboard. This may reduce tension on the mask.
6. Relax. Take normal, relaxed breaths through your nose.

---

**NOTE:** If you are having trouble with your mask, see Chapter 8, *Troubleshooting*, for some suggestions.

---

---

## 6.2 CHANGING THE DEVICE SETTINGS

You can view the following settings and indicators on the device display screen:

- Measured pressure
- Mode
- SmartCard
- Patient alarms

Additionally, you can view and modify the following settings using the display screens:

- Humidifier heat
- Flex
- Rise Time
- Ramp start pressure
- LED backlight

---

**NOTE:** When changing any setting (except for the Ramp Start Pressure setting), once a maximum setting is reached, the setting rolls back over to the minimum setting, and likewise, once a minimum setting is reached, it rolls back over to the maximum setting provided.

For example, the minimum humidifier setting is **1** and the maximum is **5**. Once the humidifier setting is increased to **5**, if you press the **Heat** button again, the setting will go back to **1**. Or, once the humidifier setting is decreased to **1**, if you press the **Ramp** button again, the setting will go back to **5**.

---

### 6.2.1 CHANGING THE HUMIDIFIER SETTING

If you are using the REMstar Heated Humidifier with your BiPAP S/T, you can adjust the humidifier heat setting by completing the following steps:

1. From either the Standby or Monitoring screen, press and hold the **Heat** button for approximately 4 seconds. The Humidifier Setting screen appears, as shown in Figure 6–6.

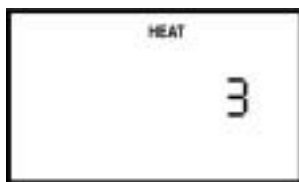

Figure 6–6 Humidifier Setting Screen

2. Press the **Heat** button to increase the humidifier setting, or press the **Ramp** button to decrease the setting. You can adjust the setting from 1 to 5. The change takes effect immediately as you adjust the setting.
3. You can exit this screen by pressing the **Left** or **Right User** buttons or the **Silence** button.

For additional information on using a humidifier with the device, see Chapter 10.

### 6.2.2 NAVIGATING THE USER DISPLAY SCREENS

You can navigate the rest of the user display screens by pressing the **Left** and **Right User** buttons.

You can change the settings on any of the display screens by pressing the **Heat** and **Ramp** buttons to increase or decrease the setting.

You can exit any of the user display screens by pressing the **Silence** button.

Figure 6–7 shows how to navigate the user display screens.

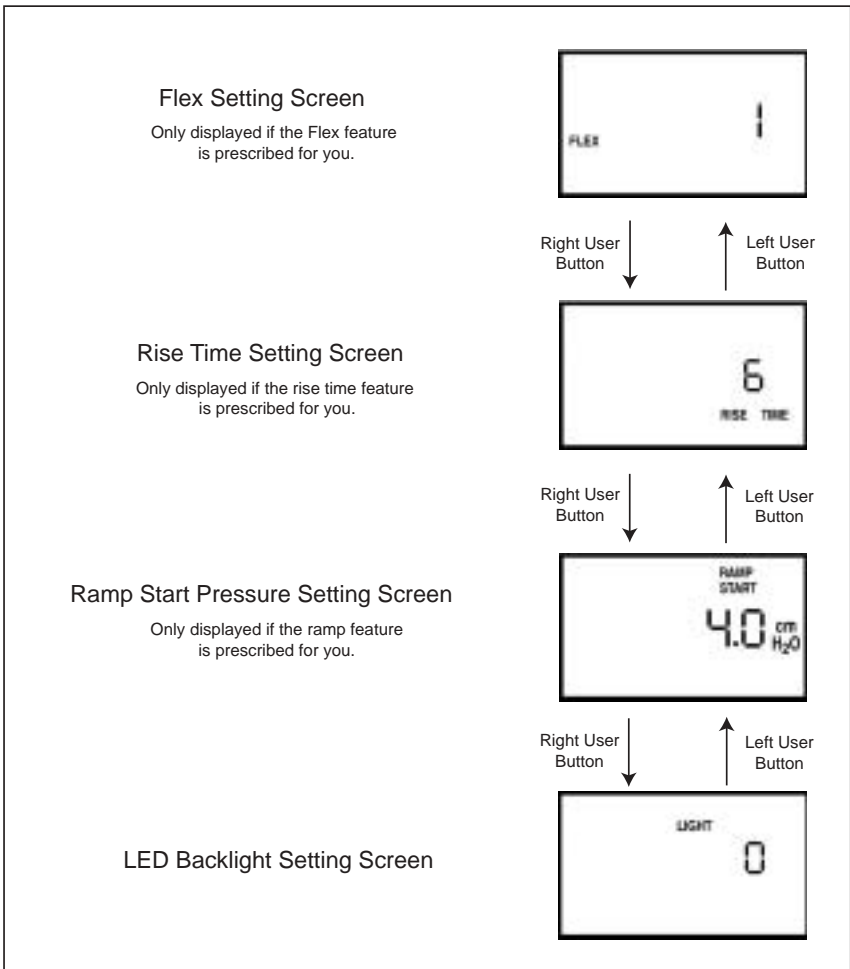

Figure 6–7 Navigating the User Display Screens

---

### 6.2.2.1 CHANGING THE FLEX SETTING

The Flex setting allows you to adjust the level of air pressure relief that you feel when you exhale during therapy.

---

**NOTE:** The Flex feature is not prescribed for all users. If the screen shown in Figure 6–8 does not appear on your display, you cannot adjust this setting.

---

To change the Flex setting, complete the following steps:

1. From either the Monitoring or Standby screens, press the **Right User** button. The Flex Setting screen appears, as shown in Figure 6–8.



**Figure 6–8 Flex Setting Screen**

2. To increase or decrease the Flex setting, press the **Heat** or **Ramp** button until the correct setting appears. You can choose from 1 to 3.

---

**NOTE:** It is recommended that you start with the minimum setting of 1, which provides the least relief. Levels 2 and 3 progressively increase the pressure relief.

---

---

### 6.2.2.2 CHANGING THE RISE TIME SETTING

Rise time is the time it takes for the device to change from EPAP to IPAP. You can adjust the rise time to find the setting that provides you with the most comfort.

---

**NOTE:** The rise time feature is not prescribed for all users. If the screen shown in Figure 6–9 does not display, you cannot adjust this setting.

Additionally, if the Flex feature has been prescribed for you, when Flex is enabled, the rise time is fixed at a setting of 3. The Rise Time screen will not display, and you won't be able to adjust the setting.

---

To change the rise time setting, complete the following steps:

1. From either the Monitoring or Standby screens, press the **Right User** button until you reach this screen. The Rise Time Setting screen is shown in Figure 6–9.



**Figure 6–9 Rise Time Setting Screen**

2. Increase or decrease the rise time setting from 1 to 6 by pressing the **Heat** or **Ramp** button until you find the right setting. A setting of 1 is the fastest rise time, while 6 is the slowest.

---

### 6.2.2.3 CHANGING THE RAMP STARTING PRESSURE

The device is equipped with an optional ramp feature. This feature will reduce the pressure and then gradually increase (ramp) the pressure to the prescription pressure setting so you can fall asleep more comfortably.

---

**NOTE:** The ramp feature is not prescribed for all users. If the screen shown in Figure 6–10 does not appear on your display, you cannot adjust this setting.

---

To change the ramp starting pressure setting, complete the following steps:

1. From either the Monitoring or Standby screens, press the **Right User** button until the Ramp Start Setting screen appears, as shown in Figure 6–10.



**Figure 6–10 Ramp Start Setting Screen**

2. Press the **Heat** or **Ramp** button to increase or decrease the ramp starting pressure as needed. You can adjust the setting from 4.0 cm H<sub>2</sub>O to your EPAP or CPAP setting.

---

#### 6.2.2.4 CHANGING THE LED BACKLIGHT SETTING

When airflow is turned on and the device is in the Operate state, you can turn the control pad lighting behind the buttons on or off using the LED backlight setting.

---

**NOTE:** The lights are always on when the airflow is off and the unit is in Standby.

---

To change the LED backlight setting, complete the following steps:

1. From either the Monitoring or Standby screens, press the **Right User** button until the LED Backlight Setting screen appears, as shown in Figure 6–11.

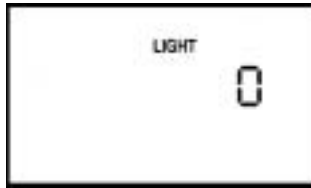

**Figure 6–11 LED Backlight Setting Screen**

2. Press the **Heat** or **Ramp** button to select a new setting. A setting of **1** means the light is on, while **0** means the light is off.



# CHAPTER 7: ALARMS

This chapter describes the BiPAP S/T alarms and what you should do if an alarm occurs.

## 7.1 INTRODUCTION TO ALARMS

The device provides three alarm levels: high, medium, and low priority.

### High Priority

These alarms require immediate response. The alarm signal consists of a red LED indicator and a sound that is either a periodic pattern consisting of a two-second beep followed by two-seconds of silence or a pattern of three beeps, a pause, and then two more beeps. The display has the message **ALARM** at the top of the screen. The tables in Section 7.3 display these sounds using the following symbols:   or • • • • •

### Medium Priority

These alarms require prompt response. The alarm signal consists of a yellow LED and a sound that repeats a pattern of three beeps. The display has the message **ALARM** at the top of the screen. The tables in Section 7.3 display these sounds using the following symbols: • • •

### Low Priority

These alarms require your awareness. The alarm signal consists of a yellow LED and a sound that repeats a pattern of two beeps. The display has the message **ALARM** at the top of the screen. The tables in Section 7.3 display these sounds using the following symbols: • •

Some audible alarms are self-cancellable. This means that the alarm sound stops when the cause of the alarm is corrected.

The alarm LED indicators are located on the right side of the control pad, as shown in Figure 7-1.

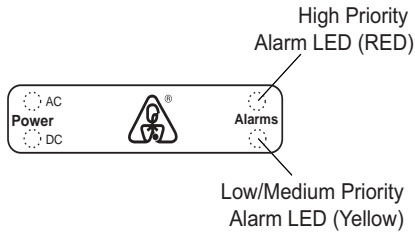

**Figure 7-1 Alarm LED Indicators**

In addition to the alarm LED indicators, the control pad also contains **Alarm Reset** and **Alarm Silence** buttons, as shown in Figure 7-2.

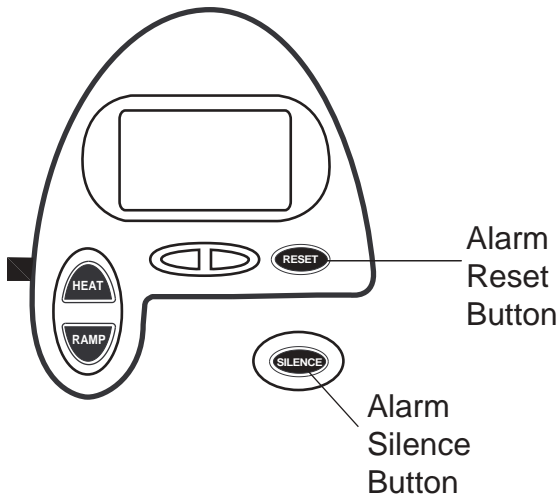
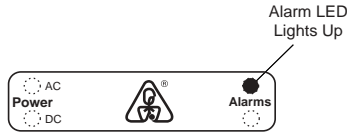

**Figure 7-2 Alarm Buttons**

## 7.2 WHAT TO DO WHEN AN ALARM OCCURS

The following example applies to most alarm conditions. Follow these steps unless otherwise directed by the alarm tables that follow.

1. Look at the alarm indicators and listen to the alarm sound.



**Figure 7-3 Alarm LED Lights Up**

Note the color of the LED and whether the LED is solid or flashing.

2. Look at the display for text.

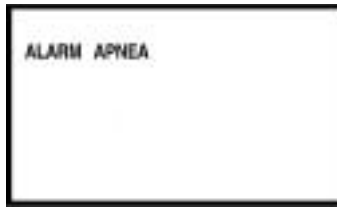

**Figure 7-4 Sample Alarm Display**

The word **ALARM** appears at the top of the screen to indicate an alarm. Additional codes and icons may also appear depending on the type of alarm.

3. Press the **Silence** button to temporarily silence the alarm (for one minute). The display returns to the screen that was showing when the alarm occurred.
4. Look up the alarm in the alarm tables in Section 7.3 and perform the action specified.
5. Press the **Reset** button to clear the alarm.

## 7.3 ALARM TABLES

The following tables summarize the high priority, medium priority, and low priority alarms.

### 7.3.1 HIGH PRIORITY ALARMS

Alarm LED	Alarm Sound	Display Message	Action	Possible Cause	Your Action
Red Flash	● ● ● ● ●	ALARM and PATIENT icons flash	Operates	Breathing circuit is disconnected or has a large leak.	Reconnect the circuit or fix the leak.
Red Flash	● ● ● ● ●	ALARM and APNEA icons flash	Operates	An apnea event occurred during therapy.	Continue using the device. Report the alarm to your home care provider.
Red Flash	● ● ● ● ●	ALARM flashes and an error code ("Exx") displays	Shuts down. Blower cannot be restarted.	Device failure	Press the <b>RESET</b> button to silence the alarm. Remove power from the unit. Restore power. If the alarm continues, contact your home care provider.
Red Flash	● ● ● ● ●	ALARM and cm H <sub>2</sub> O icons flash	Operates	Excessive leak or blockage; malfunctioning unit.	Check for the following: dirty inlet filters, blocked air intake, excessive leak in the circuit. If the alarm continues, call your home care provider.
Red Solid	■ ■	Blank screen	Shuts down	Battery is discharged.  -or-  Power was lost while the unit was providing therapy.	Remove the DC power source from the unit. Replace the battery and restore power to the unit. Or, seek a reliable AC power source.  Press the <b>Pressure On/Off</b> button to silence the alarm. Restore power.

## 7.3.2 MEDIUM PRIORITY ALARMS

Alarm LED	Alarm Sound	Display Message	Action	Possible Cause	Your Action
Yellow Flash	● ● ●	DC Power LED Flashes	Operates	Battery nearly discharged.	Replace the battery.

## 7.3.3 LOW PRIORITY ALARMS

Alarm LED	Alarm Sound	Display Message	Action	Possible Cause	Your Action
Yellow Solid	● ●	CARD flashes and card error code (Cxx) displays	Operates	<p>There is a problem with the SmartCard inserted in the SmartCard connectivity slot.</p> <p>Perhaps the SmartCard is inserted upside down or backwards.</p>	<p>Confirm that the SmartCard is properly inserted.</p> <p>If the alarm continues to occur, remove the SmartCard from the device and contact your home care provider.</p>
Yellow Solid	● ●	DC power LED flashes	Operates	<p>Device lost AC power and is now operating on DC power.</p> <p>At start-up only, alarm notifies you that a battery is being used to provide power.</p>	<p>Check the AC power. Seek a reliable power source.</p> <p>Provide AC power if you do not want to use a battery; otherwise, no action is needed.</p>
Yellow Solid	●●	Unchanged	Operates	The AC power supply is out of spec (< 22V) or there is a defective battery sense line on the DC power adapter.	Remove power from the device and then restore power. If alarm continues to occur, contact your home care provider.

## CHAPTER 8: TROUBLESHOOTING

This chapter describes problems that you may experience with your BiPAP S/T or mask and provides possible solutions.

Problem	Why It Happened	What To Do
The device does not operate when you press the <b>Pressure On/Off</b> button.	If the power LED is off, there's no power at the outlet or the device is unplugged. If the power LED is on, the problem is in the device.	Check the outlet power and verify that the device is plugged in. If the problem continues, call your home care provider.
The air out of the mask is much warmer than usual.	The inlet filters may be dirty.  The unit may be operating in direct sunlight or near a heater.	Clean or replace the inlet air filters as described in Chapter 9. Make sure the unit is away from bedding or curtains that could block the flow of air around the device. Make sure the unit is away from direct sunlight and heating equipment.  If the problem persists, contact your home care provider.
The mask feels uncomfortable to wear.	This could be due to improper headgear adjustment or improper mask fitting.	Check the headgear adjustment as described in the headgear instructions. Refer to your mask instructions to make sure the mask is properly fitted. If the problem continues, contact your home care provider for a refitting or a different size mask.

Problem	Why It Happened	What To Do
There is significant air leakage around the mask.	This could be due to improper headgear adjustment or improper mask fitting.	Check the headgear adjustment as described in the headgear instructions. Refer to your mask instructions to make sure the mask is properly fitted. If the problem continues, contact your home care provider for a refitting or a different size mask.
Redness occurs when the mask cushion comes in contact with the skin.	This could be due to improper mask fitting or improper mask cleaning.	Be sure to rinse the mask thoroughly after cleaning to remove residue. See the mask cleaning instructions for detailed information. If the problem continues, contact your home care provider for a refitting or a different size mask.
Redness occurs when the mask cushion accessory comes in contact with the skin.	Irritation or allergic reaction to the mask material.	Use a barrier between your skin and the mask, such as 3M's Microfoam <sup>®</sup> or Squibb's Duoderm <sup>®</sup> . Refer to your mask instructions for additional information.
Sore or dry eyes.	The mask may not be positioned correctly, or the mask is not properly fitted.	Check the headgear adjustment as described in the headgear instructions. Refer to your mask instructions to make sure the mask is properly fitted. If the problem continues, contact your home care provider for a refitting or a different size mask.

Problem	Why It Happened	What To Do
There are unexplained changes in the performance of the unit.	The unit or power supply has been dropped or mishandled, or water has been spilled onto or into the device or the power supply.	<p>Discontinue use.</p> <p>Contact your home care provider or Respironics for directions on how to have your unit serviced.</p> <p>Please have the serial number ready when you call.</p>
A patient disconnect alarm occurs.	The tubing has become disconnected from the system.	<p>Press the <b>RESET</b> button to silence the alarm.</p> <p>Reconnect the tubing and press the <b>Pressure On/Off</b> button to restart the airflow. If the airflow does not restart, the device may not be operating correctly. Contact your home care provider or Respironics for directions on having the unit serviced. Please have your serial number ready when you call.</p>
The mask feels uncomfortable to wear.	This could be due to improper headgear adjustment or improper mask fitting.	<p>Check the headgear adjustment as described in the headgear instructions. Refer to your mask instructions to make sure the mask is properly fitted. If the problem continues, contact your home care provider for a refitting or a different size mask.</p>

Problem	Why It Happened	What To Do
Runny nose.	Nasal reaction to the air flow.	Call your health care professional.
The unit's display is erratic.	The unit or power supply has been dropped or mis-handled, or the unit or power supply is in an area with high EMI emissions.	Unplug the unit and the power supply.  Relocate the unit to an area with lower EMI emissions.
A SmartCard error occurs.	The SmartCard is not inserted properly. It may be inserted upside down or backwards.	Remove the SmartCard and reinsert it so that the printed side of the card is facing up and the end with the arrow goes into the device first. If the error message appears again, contact your home care provider or Respironics for directions on having your unit serviced. Please have your serial number ready when you call.

---

## CHAPTER 9: CLEANING AND MAINTENANCE

This chapter provides information on how to clean and maintain your BiPAP S/T system.

### 9.1 CLEANING THE DEVICE

Before cleaning or performing any routine maintenance, always make sure the unit is not operating and disconnect the device from the power source.

---

**NOTE:** The following cleaning instructions are for the BiPAP S/T unit only. To clean the accessories, refer to each accessory's instruction sheet.

---

**CAUTION:** Do not immerse the unit or allow any liquid to enter the enclosure, inlet filter, or any openings.

---

Clean the front panel and exterior of the enclosure as needed using a cloth dampened with water and a mild detergent. Allow the device to dry completely before plugging in the power cord.

Gently wash the reusable circuit tubing in a solution of warm water and a mild detergent. Rinse thoroughly and allow to air dry.

### 9.2 CLEANING OR REPLACING THE INLET FILTERS

The device has two removable filters at the air inlet. The gray foam filter is washable and reusable. The optional white, ultra-fine filter is disposable. The gray foam filter should be cleaned at least once every two weeks under normal usage and replaced with a new one every six months. The white ultra-fine filter is disposable and should be replaced after 30 nights of use or sooner if it appears dirty. **Do not** attempt to clean the ultra-fine filter. It will damage the filter.

---

**NOTE:** Dirty inlet filters may cause high operating temperatures and may affect performance. Regularly examine the inlet filters as needed for integrity and cleanliness.

---

1. Make sure the device is not operating, and disconnect the power cord from the wall outlet or DC source.
2. As shown in Figure 9–1, remove the filter cap by gently pressing down on the top panel and pulling the cap out, away from the device.

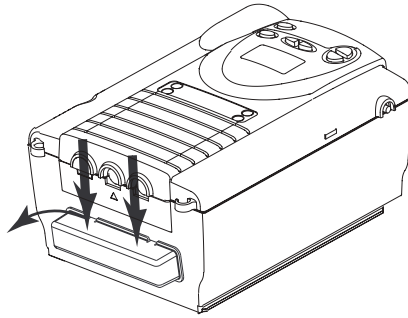

**Figure 9–1 Removing the Filter**

3. Remove the filters from the enclosure as shown in Figure 9–2. The top filter is the reusable gray foam filter. The bottom filter is the optional disposable, white, ultra-fine filter.

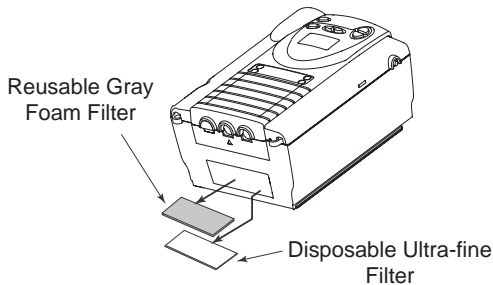

**Figure 9–2 Removing the Air Filters**

4. Check the filters to see if they are dirty or torn.

- 
5. If needed, wash the gray foam filter in warm water and a mild detergent. Rinse the filter thoroughly to remove all detergent residue. Allow the filter to completely dry before reinstalling it. If the pollen filter is torn, replace it.
  6. If the ultra-fine filter is dirty or torn, replace it.
  7. Reinstall the filters, with the ultra-fine filter on the bottom. Slide the filters into the air inlet at the rear of the device and push them down into the recess.
  8. Replace the filter cap.

Contact your home care provider to order additional filters.

---

**NOTE:** To clean the breathing circuit accessories, refer to each accessory's instruction sheet.

---

---

## CHAPTER 10: ACCESSORIES

There are several accessories you can use with the device.

### 10.1 ADDING A HUMIDIFIER

The REMstar Heated Humidifier, REMstar Pass-over Humidifier, and H2 Heated Humidifier are available from your home care provider. The humidifiers may reduce nasal dryness and irritation by adding moisture (and heat, if applicable) to the airflow.

---

**CAUTION:** For safe operation, the humidifier must always be positioned below the circuit connection at the mask and the air outlet on the device. The humidifier must be level for proper operation.

---

Refer to the humidifier instructions for complete setup information.

### 10.2 ADDING OXYGEN TO THE DEVICE

Oxygen may be added to the mask connection. Please note the warnings listed below when using oxygen with the device.

---

**WARNING:** If you are using oxygen, your BiPAP S/T must be equipped with the Respironics Pressure Valve (Part number 302418). Failure to use the Pressure Valve could result in a fire hazard.

**WARNING:** Oxygen accelerates fires. Keep the device and the O<sub>2</sub> containers away from heat, open flames, any oily substance, or other sources of ignition. Do not smoke in the area near the device or the O<sub>2</sub> container.

**WARNING:** When using oxygen with your device, the oxygen supply must comply with the local regulations for medical oxygen.

**WARNING:** When using oxygen with this system, turn the device **on** before turning the oxygen on. Turn the oxygen **off** before turning the device off. This will prevent oxygen accumulation in the device.

---

# CHAPTER 11: SPECIFICATIONS

## ENVIRONMENTAL

	Operating	Storage
Temperature	41°F to 95 °F	-4°F to 140°F
Relative Humidity	15 to 95% (non-condensing)	15 to 95% (non-condensing)
Atmospheric Pressure	83 to 102kPa (5600 feet to sea level)	

## PHYSICAL

Dimensions: 9.75" L x 6.625" W x 4.4" H

Weight: Approximately 4 lb.

## ELECTRICAL

AC Voltage Source: 100 to 240 V, 50/60 Hz

DC Voltage Source: 24 VDC (when operated with the external DC power adaptor accessory)

AC Current: 1.25 A maximum

DC Current: 3.0 A maximum

Protection against electric shock: Class II

Degree of protection against electric shock: Type BF Applied Part

Degree of protection against harmful ingress of water:

BiPAP S/T unit: Ordinary Equipment, IPX0

AC Power Supply (Reorder number 1012832): Drip Proof, IPX1

DC Power Adapter (Reorder number 1012975): Drip Proof, IPX1

Modes of Operation: Continuous

Electromagnetic Compatibility: The BiPAP S/T meets the requirements of EN 60601-1-2, second edition (2001).

**Fuses:** There are no user-replaceable fuses.

## PRESSURE

**Output:** 4 to 30 cm H<sub>2</sub>O

## CONTROL ACCURACY

Parameter	Range	Accuracy
IPAP	4 to 30 cm H <sub>2</sub> O*	± 5 cm H <sub>2</sub> O**
EPAP	4 to 25 cm H <sub>2</sub> O*	± 5 cm H <sub>2</sub> O**
CPAP	4 to 20 cm H <sub>2</sub> O	± 5 cm H <sub>2</sub> O**
Breath Rate	0 to 30 BPM	Greater of ± 1 BPM or ± 10% of the setting (when measured over a 4 minute period)
Timed Inspiration	0.5 to 3.0 seconds	± (0.1 + 10% of the setting) seconds
Ramp Duration	0 to 45 minutes	± 10% of the setting
Rise Time	1 to 6***	± 25%****

\* Limited to 20 cm H<sub>2</sub>O when using the Bi-Flex feature in S mode.

\*\* Dynamic pressure accuracy is ± 5 cm H<sub>2</sub>O measured at the patient end of the circuit with a Whisper Swivel II and varying flow conditions.

\*\*\* The range of values correspond to tenths of seconds (e.g., a setting of 4 indicates a Rise Time of 0.4 seconds).

\*\*\*\* Measured at the patient end of circuit with a Whisper Swivel II exhalation device and no patient flow.

## DISPOSAL

When necessary, dispose of the BiPAP S/T and accessories in accordance with local regulations.

## APPENDIX A: EMC INFORMATION

### GUIDANCE AND MANUFACTURER'S DECLARATION - ELECTROMAGNETIC EMISSIONS

This device is intended for use in the electromagnetic environment specified below. The user of this device should make sure it is used in such an environment.

Emissions Test	Compliance	Electromagnetic Environment - Guidance
RF emissions CISPR 11	Group 1	This device uses RF energy only for its internal function. Therefore, its RF emissions are very low and are not likely to cause any interference in nearby electronic equipment.
RF emissions CISPR 11	Class B	This device is suitable for use in all establishments, including domestic establishments and those directly connected to the public low-voltage power supply network.
Harmonic emissions IEC 61000-3-2	Class A	
Voltage fluctuations/ Flicker emissions IEC 61000-3-3	Complies	

## GUIDANCE AND MANUFACTURER'S DECLARATION - ELECTROMAGNETIC IMMUNITY

This device is intended for use in the electromagnetic environment specified below. The user of this device should make sure it is used in such an environment.

Immunity Test	IEC 60601 Test Level	Compliance Level	Electromagnetic Environment - Guidance
Electrostatic Discharge (ESD)  IEC 61000-4-2	$\pm 6$ kV contact  $\pm 8$ kV air	$\pm 6$ kV contact  $\pm 8$ kV air	Floors should be wood, concrete or ceramic tile. If floors are covered with synthetic material, the relative humidity should be at least 30%.
Electrical fast Transient/burst  IEC 61000-4-4	$\pm 2$ kV for power supply lines  $\pm 1$ kV for input-output lines	$\pm 2$ kV for supply mains  $\pm 1$ kV for input/output lines	Mains power quality should be that of a typical home or hospital environment.
Surge IEC 61000-4-5	$\pm 1$ kV differential mode  $\pm 2$ kV common mode	$\pm 1$ kV differential mode  $\pm 2$ kV for common mode	Mains power quality should be that of a typical home or hospital environment.
Voltage dips, short interruptions and voltage variations on power supply input lines  IEC 61000-4-11	$<5\% U_T$ ( $>95\%$ dip in $U_T$ ) for 0.5 cycle $40\% U_T$ ( $60\%$ dip in $U_T$ ) for 5 cycles $70\% U_T$ ( $30\%$ dip in $U_T$ ) for 25 cycles $<5\% U_T$ ( $>95\%$ dip in $U_T$ ) for 5 sec	$<5\% U_T$ ( $>95\%$ dip in $U_T$ ) for 0.5 cycle $40\% U_T$ ( $60\%$ dip in $U_T$ ) for 5 cycles $70\% U_T$ ( $30\%$ dip in $U_T$ ) for 25 cycles $<5\% U_T$ ( $>95\%$ dip in $U_T$ ) for 5 sec	Mains power quality should be that of a typical home or hospital environment.
<b>NOTE:</b> $U_T$ is the a.c. mains voltage prior to application of the test level.			

## **GUIDANCE AND MANUFACTURER'S DECLARATION - ELECTROMAGNETIC IMMUNITY**

This device is intended for use in the electromagnetic environment specified below. The user of this device should make sure it is used in such an environment.

<b>Immunity Test</b>	<b>IEC 60601 Test Level</b>	<b>Compliance Level (FDA)</b>	<b>Electromagnetic Environment - Guidance</b>
Power frequency (50/60 Hz) magnetic field  IEC 61000-4-8	3 A/m	3 A/m	Power frequency magnetic fields should be at levels characteristic of a typical location in a typical home or hospital environment.

## GUIDANCE AND MANUFACTURER'S DECLARATION - ELECTROMAGNETIC IMMUNITY

This device is intended for use in the electromagnetic environment specified below. The user of this device should make sure it is used in such an environment.

Immunity Test	IEC 60601 Test Level	Compliance Level	Electromagnetic Environment - Guidance
Conducted RF IEC 61000-4-6  Radiated RF IEC 61000-4-3	3 Vrms 150 kHz to 80 MHz  3 V/m 80 MHz to 2.5 GHz	3 Vrms  3 V/m	<p>Portable and mobile RF communications equipment should be used no closer to any part of the device, including cables, than the recommended separation distance calculated from the equation applicable to the frequency of the transmitter.</p> <p><b>Recommended separation distance</b>  <math>d = 1.2\sqrt{P}</math>  <math>d = 1.2\sqrt{\frac{P}{f}}</math>    80 MHz to 800 MHz  <math>d = 2.3\sqrt{\frac{P}{f}}</math>    800 MHz to 2.5 GHz</p> <p>where P is the maximum output power rating of the transmitter in watts (W) according to the transmitter manufacturer and d is the recommended separation distance in meters (m).</p> <p>Field strengths from fixed RF transmitters, as determined by an electromagnetic site survey,<sup>a</sup> should be less than the compliance level in each frequency range.<sup>b</sup></p> <p>Interference may occur in the vicinity of equipment marked with the following symbol:</p> 

NOTE 1 At 80 MHz and 800 MHz, the higher frequency range applies.

NOTE 2 These guidelines may not apply in all situations. Electromagnetic propagation is affected by absorption and reflection from structures, objects, and people.

<sup>a</sup> Field strengths from fixed transmitters, such as base stations for radio (cellular/cordless) telephones and land mobile radios, amateur radio, AM and FM radio broadcast and TV broadcast cannot be predicted theoretically with accuracy. To assess the electromagnetic environment due to fixed RF transmitters, an electromagnetic site survey should be considered. If the measured field strength in the location in which the device is used exceeds the applicable RF compliance level above, the device should be observed to verify normal operation. If abnormal performance is observed, additional measures may be necessary, such as re-orienting or relocating the device.

<sup>b</sup> Over the frequency range 150 kHz to 80 MHz, the field strengths should be less than 3 V/m.

## RECOMMENDED SEPARATION DISTANCES BETWEEN PORTABLE AND MOBILE RF COMMUNICATIONS EQUIPMENT AND THIS DEVICE

This device is intended for use in an electromagnetic environment in which radiated RF disturbances are controlled. The customer or the user of this device can help prevent electromagnetic interference by maintaining a minimum distance between portable and mobile RF communications equipment (transmitters) and this device as recommended below, according to the maximum output power of the communications equipment.

Rated Maximum Power Output of Transmitter W	Separation Distance According to Frequency of Transmitter m		
	150 kHz to 80 MHz $d = 1.2\sqrt{P}$	80 MHz to 800 MHz $d = 1.2\sqrt{P}$	800 MHz to 2.5 GHz $d = 2.3\sqrt{P}$
0.01	0.12	0.12	0.23
0.1	0.38	0.38	0.73
1	1.2	1.2	2.3
10	3.8	3.8	7.3
100	12	12	23

For transmitters rated at a maximum output power not listed above, the recommended separation distance  $d$  in meters (m) can be estimated using the equation applicable to the frequency of the transmitter, where  $P$  is the maximum output power rating of the transmitter in watts (W) according to the transmitter manufacturer.

Note 1: At 80 MHz and 800 MHz, the separation distance for the higher frequency range applies.

Note 2: These guidelines may not apply in all situations. Electromagnetic propagation is affected by absorption and reflection from structures, objects, and people.

## LIMITED WARRANTY

Respironics, Inc. warrants that the BiPAP S/T system shall be free from defects of workmanship and materials and will perform in accordance with the product specifications for a period of two (2) years from the date of sale by Respironics, Inc. to the dealer. If the product fails to perform in accordance with the product specifications, Respironics, Inc. will repair or replace – at its option – the defective material or part. Respironics, Inc. will pay customary freight charges from Respironics, Inc. to the dealer location only. This warranty does not cover damage caused by accident, misuse, abuse, alteration, and other defects not related to material or workmanship.

Respironics, Inc. disclaims all liability for economic loss, loss of profits, overhead, or consequential damages which may be claimed to arise from any sale or use of this product. Some states do not allow the exclusion or limitation of incidental or consequential damages, so the above limitation or exclusion may not apply to you.

This warranty is given in lieu of all other express warranties. In addition, any implied warranties – including any warranty of merchantability or fitness for the particular purpose – are limited to two years. Some states do not allow limitations on how long an implied warranty lasts, so the above limitation may not apply to you. This warranty gives you specific legal rights, and you may also have other rights which vary from state to state.

To exercise your rights under this warranty, contact your local authorized Respironics, Inc. dealer or contact Respironics, Inc. at:

1001 Murry Ridge Lane  
Murrysville, Pennsylvania 15668-8550  
1-724-387-4000

**[ P E O P L E ]**  
**[ P R O D U C T S ]**  
**[ P R O G R A M S ]**



**RESPIRONICS®**  
1001 Murry Ridge Lane  
Murrysville, Pennsylvania  
15668-8550 USA

**RESPIRONICS®**  
Deutschland  
Gewerbestrasse 17  
82211 Herrsching Germany



1001249  
JH 3/10/05